



# LED Display Product Data Sheet LTS-50301HRB

Spec No.: DS-30-98-247

Effective Date: 04/21/2000

Revision: -

**LITE-ON DCC**

**RELEASE**

BNS-OD-FC001/A4

**FEATURES**

- \* 5-INCH (127.0-mm ) DIGIT HEIGHT.
- \* CONTINUOUS UNIFORM SEGMENTS.
- \* LOW POWER REQUIREMENT.
- \* EXCELLENT CHARACTERS APPEARANCE.
- \* HIGH BRIGHTNESS & HIGH CONTRAST.
- \* WIDE VIEWING ANGLE.
- \* SOLID STATE RELIABILITY.
- \* CATEGORIZED FOR LUMINOUS INTENSITY.

**DESCRIPTION**

The LTS-50301HRB is a 5-inch (127.0-mm) height single digit seven-segment display. This device utilizes hi-eff. red LED chips, which are made from GaAsP on GaP substrate, and has a black face and red segments.

**DEVICE**

| <b>PART NO.</b>     | <b>DESCRIPTION</b>    |
|---------------------|-----------------------|
| <b>HI-EFF. RED</b>  | <b>Common Cathode</b> |
| <b>LTS-50301HRB</b> |                       |

**PACKAGE DIMENSIONS**

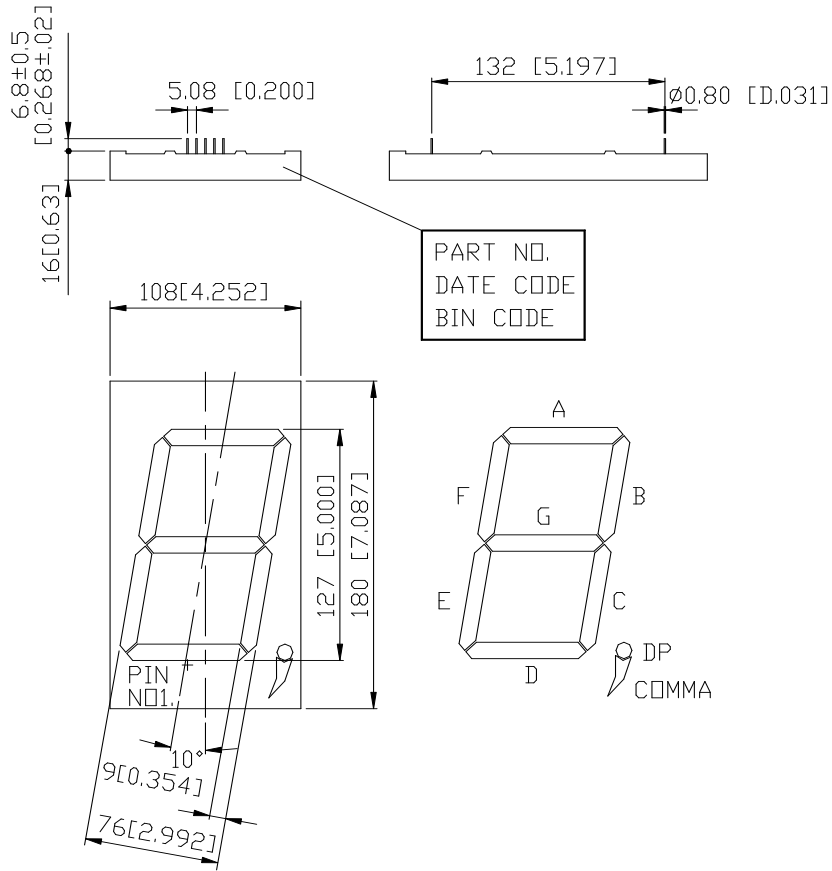

NOTES: All dimensions are in millimeters. Tolerance is ±0.25mm(0.01“) unless otherwise noted.

**INTERNAL CIRCUIT DIAGRAM**

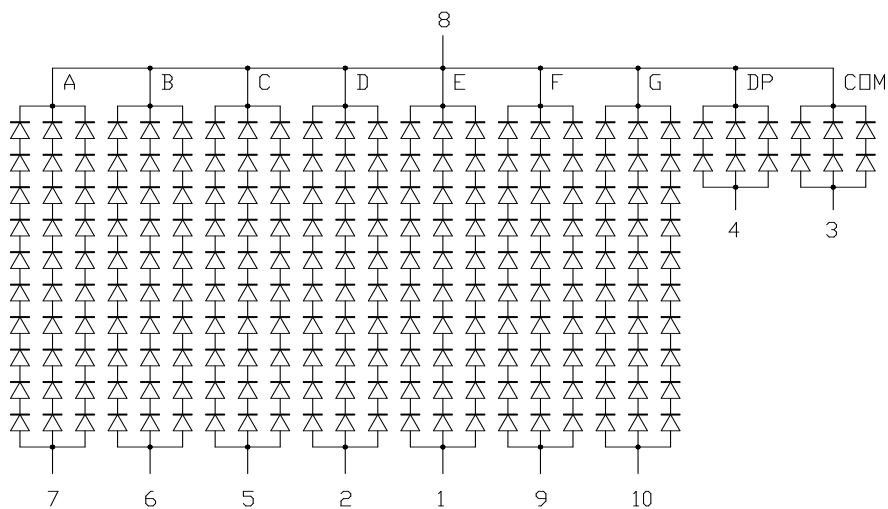

**PIN CONNECTION**

| <b>No</b> | <b>CONNECTION</b> |
|-----------|-------------------|
| 1         | SEGMENT E ANODE   |
| 2         | SEGMENT D ANODE   |
| 3         | COMMA ANODE       |
| 4         | D.P. ANODE        |
| 5         | SEGMENT C ANODE   |
| 6         | SEGMENT B ANODE   |
| 7         | SEGMENT A ANODE   |
| 8         | COMMON CATHODE    |
| 9         | SEGMENT F ANODE   |
| 10        | SEGMENT G ANODE   |

**ABSOLUTE MAXIMUM RATING AT Ta=25°C**

| PARAMETER   | MAXIMUM RATING | UNIT  |
|---|----------------|-------|
| Power Dissipation Per Segment   | 1200           | mW    |
| Peak Forward Current Per Segment<br>(1/10 Duty Cycle, 0.1ms Pulse Width ) | 180            | mA    |
| Continuous Forward Current Per Segment                                    | 60             | mA    |
| Derating Linear From 25°C Per Segment                                     | 0.72           | mA/°C |
| Reverse Voltage Per Segment   | 50             | V     |
| Operating Temperature Range   | -35°C to +85°C |       |
| Storage Temperature Range   | -35°C to +85°C |       |
| Solder Temperature 1/16 inch Below Seating Plane for 3 Seconds at 260°C   |                |       |

**ELECTRICAL / OPTICAL CHARACTERISTICS AT Ta=25°C**

| PARAMETER                         | SYMBOL            | MIN. | TYP.        | MAX.        | UNIT | TEST CONDITION       |
|-----------------------------------|-------------------|------|-------------|-------------|------|----------------------|
| Average Luminous Intensity        | I <sub>v</sub>    | 21   | 60          |             | mcd  | I <sub>F</sub> =30mA |
| Peak Emission Wavelength          | λ <sub>p</sub>    |      | 635         |             | nm   | I <sub>F</sub> =20mA |
| Spectral Line Half-Width          | Δλ                |      | 40          |             | nm   | I <sub>F</sub> =20mA |
| Dominant Wavelength               | λ <sub>d</sub>    |      | 623         |             | nm   | I <sub>F</sub> =20mA |
| Forward Voltage Per Segment       | V <sub>F</sub>    |      | 20<br>(4.0) | 26<br>(5.2) | V    | I <sub>F</sub> =60mA |
| Reverse Current Per Segment       | I <sub>R</sub>    |      |             | 300         | μA   | V <sub>R</sub> =50V  |
| Luminous Intensity Matching Ratio | I <sub>v</sub> -m |      |             | 2:1         |      | I <sub>F</sub> =10mA |

Note: Luminous intensity is measured with a light sensor and filter combination that approximates the CIE (commision internationale DE L'clairiage ) eye-response curve.

**TYPICAL ELECTRICAL / OPTICAL CHARACTERISTIC CURVES**

(25°C Ambient Temperature Unless Otherwise Noted )

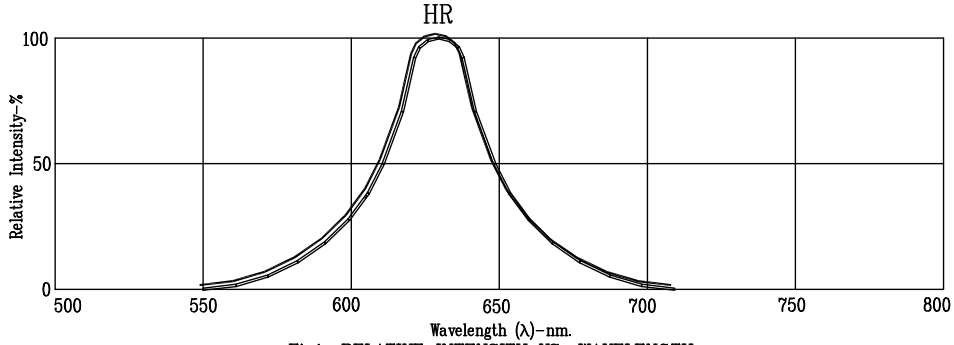

Fig1. RELATIVE INTENSITY VS. WAVELENGTH

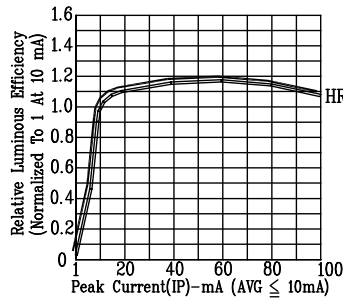

Fig2. RELATIVE LUMINOUS EFFICIENCY (LUMINOUS INTENSITY PER UNIT CURRENT) VS. PEAK CURRENT (REFRESH RATE 1KHz)

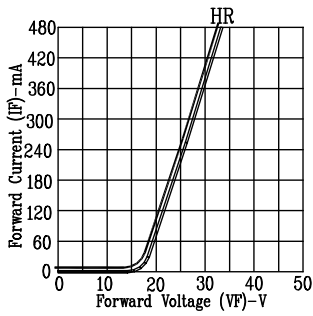

Fig3. FORWARD CURRENT VS. FORWARD VOLTAGE

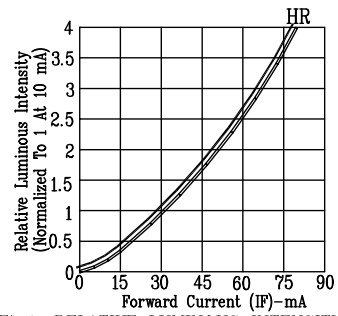

Fig4. RELATIVE LUMINOUS INTENSITY VS. FORWARD CURRENT

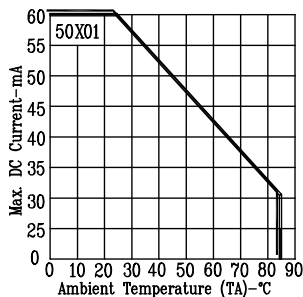

Fig5. MAX. ALLOWABLE DC CURRENT VS. AMBIENT TEMPERATURE.

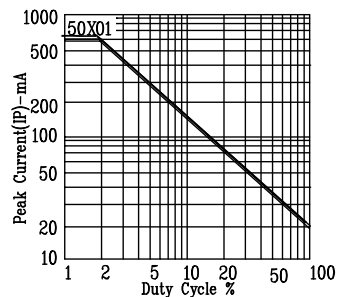

Fig6. MAX PEAK CURRENT VS. DUTY CYCLE % (REFRESH RATE 1KHz)

NOTE : HR=HI.EFF.RED