

33447-MS MotorData

Specifications

Model	Step Angle	Rated Voltage	Rated Current	Resistance	Holding Torque	Inductance	Rotor Inertia	Detent Torque	Mass
	(deg)	(V)	(A)	(Ohms)	(mNm)	(mH)	(g·cm ²)	(mNm)	(g)
17PM-K374BN02CN	1.8	10.4	0.33	32	340	71	50	11.3	250

Step Accuracy	Radial Play	End Play	Insulation R	Drive Sequence	Temp. Rise
(deg)	nanometers	nanometers	(Ohms)		(deg. "C")
+/-0.09	20	80	100meg.	BI-POLAR	80

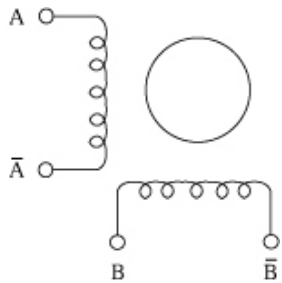
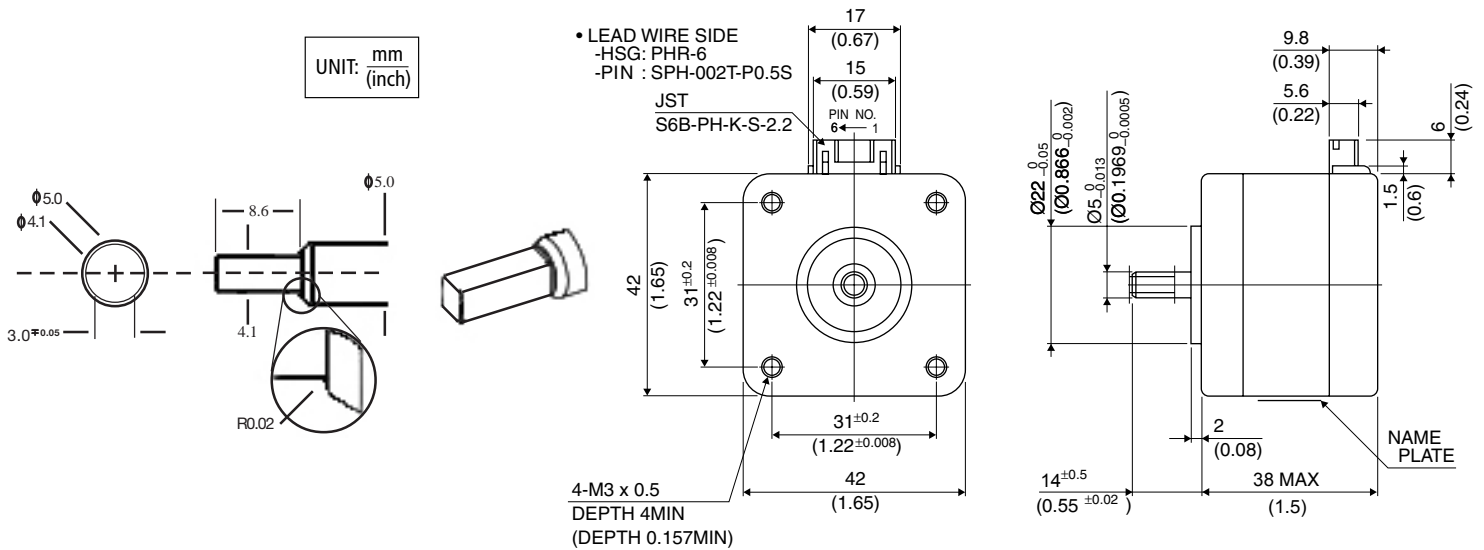

No.	Red	Blue	Yel	Org
1	+	+	-	-
2	-	+	+	-
3	-	-	+	+
4	+	-	-	+

PIN NO. vs. PHASE

PHASE	A		Ā	B		B̄
PIN NO.	4	5	6	3	2	1
COLOR	Red		Yel	Org		Blue



MARLIN P. JONES & ASSOC., INC.

P.O. Box 530400 Lake Park, FL 33403

800-652-6733 FAX 561-844-8764

WWW.MPJA.COM