

33152-ME

300V/50A AC Panel Meter

Snap-in LED Digital panel meter contains both a 3 digit AC Volt Meter and a 3 digit AC Ammeter with built-in Current Transformer

Character Height: 0.38in.

Voltage: 60-300VAC Resolution: 1V

Current: 0-50A Resolution: .1 Amp

Accuracy: +-1% +2LSD

Current Transformer: 7.3mm ID.

Cutout: W: 68mm H: 38mm

W: 2-3/4" H: 1-5/8" D: 1-5/8" WT: .12



NOTES: DO NOT MISSWIRE

Only one lead to the Load should pass through the Current Transformer
Designed for Sine Wave Power ONLY

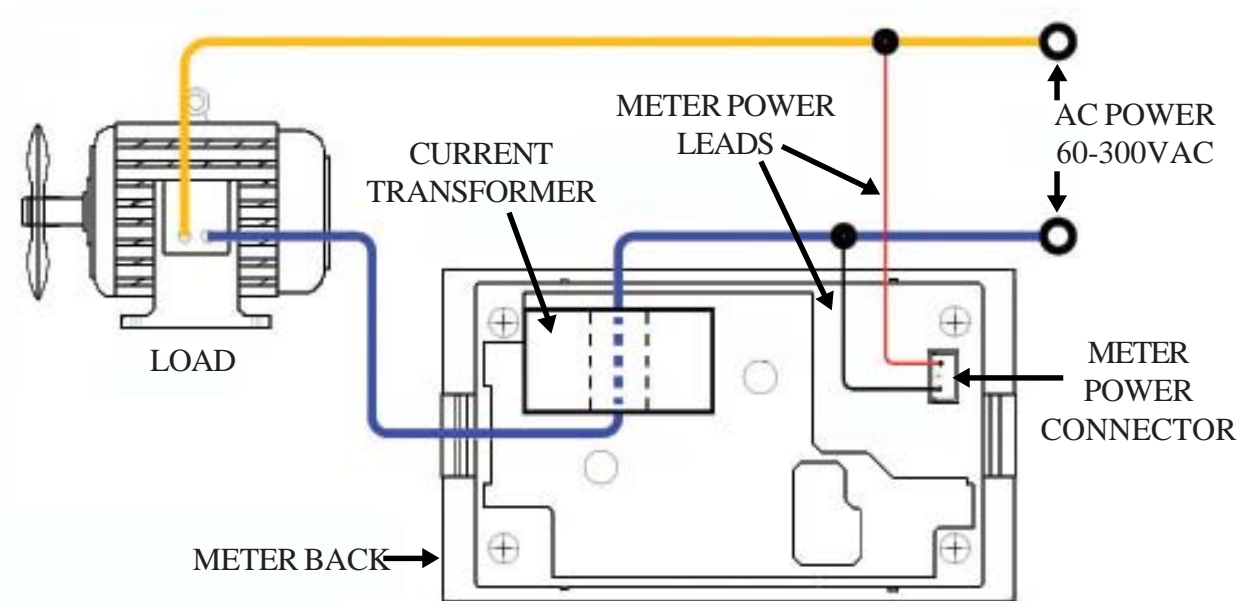

Information obtained from or supplied by Mpja.com or Marlin P. Jones and Associates inc. is supplied as a service to our customers and accuracy is not guaranteed nor is it definitive of any particular part or manufacturer. Use of information and suitability for any application is at users own discretion and user assumes all risk.



MARLIN P. JONES & ASSOC., INC.

P.O. Box 530400 Lake Park, FL 33403

800-652-6733 FAX 561-844-8764

WWW.MPJA.COM